ROBOTICS

Application manual

CC-Link IE Field Basic



Trace back information:
Workspace 23D version a12
Checked in 2023-12-06
Skribenta version 5.5.019

Application manual
CC-Link IE Field Basic
RobotWare 7.13

Document ID: 3HAC082295-001
Revision: E

The information in this manual is subject to change without notice and should not be construed as a commitment by ABB. ABB assumes no responsibility for any errors that may appear in this manual.

Except as may be expressly stated anywhere in this manual, nothing herein shall be construed as any kind of guarantee or warranty by ABB for losses, damage to persons or property, fitness for a specific purpose or the like.

In no event shall ABB be liable for incidental or consequential damages arising from use of this manual and products described herein.

This manual and parts thereof must not be reproduced or copied without ABB's written permission.

Keep for future reference.

Additional copies of this manual may be obtained from ABB.

Original instructions.

© Copyright 2022-2023 ABB. All rights reserved.
Specifications subject to change without notice.

Table of contents

Overview of this manual	7
Network security	9
1 Introduction	11
1.1 What is CC-Link IE Field Basic	11
1.2 CC-Link IE Field Basic for OmniCore	12
2 Quick start instructions	15
3 Setting up your CC-Link IE Field Basic system	17
4 Configuring the CC-Link IE Field Basic system	21
4.1 Configuring the internal device properties	21
4.2 Configuring the master network properties	23
4.3 Adding external devices to the master	25
4.4 Configuring the external device properties	26
4.5 Working with signals	28
4.6 Saving the configuration	29
Index	31

This page is intentionally left blank

Overview of this manual

About this manual

This manual describes the following options and contains instructions on how to configure them in an OmniCore system.

- 3066-1 *CC-Link IE Field Basic Master*
- 3066-2 *CC-Link IE Field Basic Device*



Note

It is the responsibility of the integrator to provide safety and user guides for the robot system.

Usage

This manual should be used during installation and configuration of the option for CC-Link IE Field Network Basic.



Note

Before any work on or with the robot is performed, the safety information in the product manual for the controller and manipulator must be read.

Who should read this manual?

This manual is intended for:

- Personnel that are responsible for installations and configurations of industrial network hardware/software.
- Personnel that make the configurations of the I/O system.
- System integrators.

Prerequisites

The reader should have the required knowledge of:

- CC-Link network
- I/O system configuration
- OmniCore controller
- RobotStudio

References

ABB documents

Reference	Document ID
<i>Application manual - I/O Engineering</i>	3HAC082346-001
<i>Technical reference manual - System parameters</i>	3HAC065041-001
<i>Product manual - OmniCore C30</i>	3HAC060860-001
<i>Product manual - OmniCore C90XT</i>	3HAC073706-001

Continues on next page

Overview of this manual

Continued

Reference	Document ID
<i>Product manual - OmniCore E10</i>	3HAC079399-001
<i>Operating manual - OmniCore</i>	3HAC065036-001
<i>Operating manual - RobotStudio</i>	3HAC032104-001
<i>Operating manual - Integrator's guide OmniCore</i>	3HAC065037-001

Other references

Reference	Description
https://www.cc-link.org/	CC-Link Partner Association (CLPA)

Revisions

Revision	Description
A	First edition. Released with RobotWare 7.6.
B	Released with RobotWare 7.7. <ul style="list-style-type: none">• Minor corrections in CC-Link IE Field Basic for OmniCore on page 12.• Reference to AM I/O Engineering added, and section "I/O Engineering user interface" removed.
C	Released with RobotWare 7.10. <ul style="list-style-type: none">• Minor updates in CC-Link IE Field Basic for OmniCore on page 12.
D	Released with RobotWare 7.12. <ul style="list-style-type: none">• Option 3066-1 <i>CC-Link IE Field Basic Master</i> added.
E	Released with RobotWare 7.13. <ul style="list-style-type: none">• Minor updates in Network connections on page 13.

Network security

Network security

This product is designed to be connected to and to communicate information and data via a network interface. It is your sole responsibility to provide, and continuously ensure, a secure connection between the product and to your network or any other network (as the case may be).

You shall establish and maintain any appropriate measures (such as, but not limited to, the installation of firewalls, application of authentication measures, encryption of data, installation of anti-virus programs, etc) to protect the product, the network, its system and the interface against any kind of security breaches, unauthorized access, interference, intrusion, leakage and/or theft of data or information. ABB Ltd and its entities are not liable for damage and/or loss related to such security breaches, any unauthorized access, interference, intrusion, leakage and/or theft of data or information.

This page is intentionally left blank

1 Introduction

1.1 What is CC-Link IE Field Basic

General

CC-Link IE is a protocol for communication between a PLC (Programmable Logic Controller) and remote input/output devices. CC-Link IE is governed by the CC-Link Partner Association (CLPA).

Standardization

CC-Link IE conforms to the following international standards:

- International Standard: ISO, ISO15745-5
- International Standard: IEC, IEC61158 and IEC61784

Communication profiles

CC-Link IE has a modular design and different communication profiles are all combinations of modular elements from the groups transmission technology, communication protocol, and application profiles.

The communication profile used in CC-Link IE for OmniCore is CC-Link IE Field Basic. This is a Ethernet based network with the following characteristics:

- Standard Ethernet UDP/IP communication.
- Cyclic communication between master and devices.
- Devices can be assigned to groups. The master station talks to each group sequentially. Each device belongs to one group only.

CSP+ file

CC-Link IE uses CSP+ files (.csp) for configuration. The CSP+ (Control & Communication System Profile Plus) file is an XML-based format file that is used to describe the devices (network parameter information, memory map, etc.). The file can be imported into the engineering tool, and is used to set up the communication between the PLC/controller and the devices.

Data

The following table specifies a number of CC-Link IE data:

Network type	Ethernet based
Communication profile	CC-Link IE Field Basic
Installation	Standard Off the Shelf (COTS) Ethernet cables and connectors. 10/100/1000 Mbit/s TX Ethernet cable or fibre optics. RJ45, M12 or fibre optic connectors.
Speed	100 Mbit/s
Hardware requirements	No specialized hardware required.
Number of stations per network	64

1 Introduction

1.2 CC-Link IE Field Basic for OmniCore

1.2 CC-Link IE Field Basic for OmniCore

General

The CC-Link IE Field Basic network is running on the OmniCore main computer and does not require any additional hardware.

Options

In order to run CC-Link IE Field Basic, the following options are required:

- 3066-1 *CC-Link IE Field Basic Master*
- 3066-2 *CC-Link IE Field Basic Device*



Note

In this manual, the 3066-2 *CC-Link IE Field Device* is referred to as *internal device*.

Compatibility

CC-Link IE Field Basic has passed conformance tests to ensure compatibility according to the CC-Link IE Conformance Test Regulation from CC-Link Partner Association (CLPA).

The device is certified for the CC-Link IE Field Basic version 2.

Specification overview, external device

Item	Specification
CC-Link IE Field Basic version	2
Connection size	Maximum 16 devices per master.



Note

No cyclic time can be set. The external devices will answer as fast they can.

Specification overview, internal device

Item	Specification
CC-Link IE Field Basic version	2
CSP+ version	CCLinkFamilyProfileVersion 2.2
Connection size	Maximum 288 input bytes and 288 output bytes.
Number of stations per internal device	Maximum 4 stations. Each station holds 72 bytes.

Predefined internal device

When the robot system is installed with the CC-Link IE Field Network Basic option, a predefined network with the name **CC_Link_IE** and a device with the name **CC_Internal_Device** are created at system startup.

Continues on next page

The network and the internal device are ready to be used at once, see [Quick start instructions on page 15](#).

However, if needed, the internal device can be configured using I/O Engineering in RobotStudio. For example, you can define device names, identification labels, input and output sizes and edit signals, see [Configuring the CC-Link IE Field Basic system on page 21](#).



Note

The defined IP address controls whether CC_Link_IE is run on the Public Network or the I/O Network.

Application protocols

For information about application protocols and port numbers, see section "OmniCore application protocols" in *Operating manual - Integrator's guide OmniCore*.

Network connections



Note

For information regarding port connectors for the network segments, see *Operating manual - Integrator's guide OmniCore* or the Product manual for the respective OmniCore controller.



Note

No manual port selection is needed for the device, as the internal device automatically detects to which interface the device is connected.

CC-Link on public network

The following figure illustrates the network when connecting a PLC to the WAN port of the main computer:

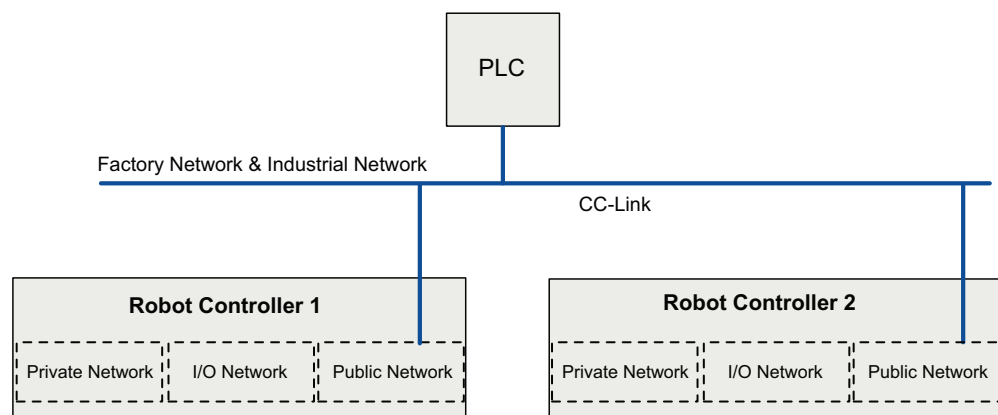

xx230000132

Continues on next page

1 Introduction

1.2 CC-Link IE Field Basic for OmniCore

Continued

CC-Link on I/O network

The following figure illustrates the network when connecting a PLC to the I/O network:

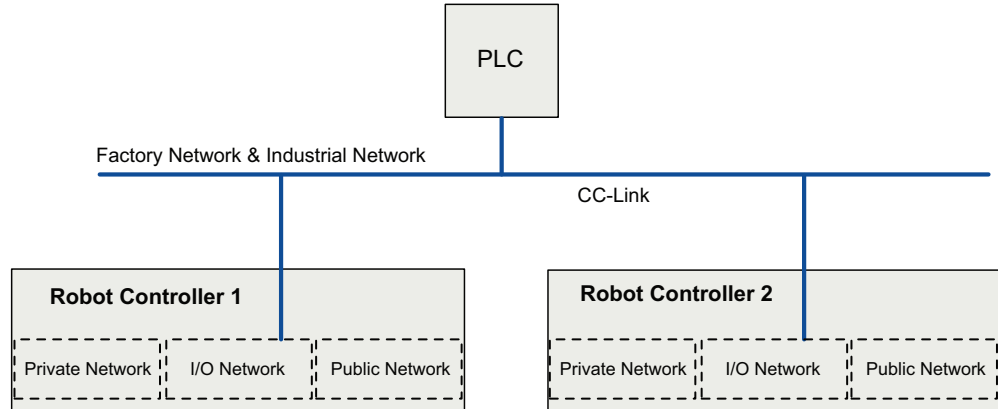

xx2300000216



Note

The I/O Network is not available for OmniCore E10.

CC-Link with internal and external devices

Internal and external devices on CC-Link cannot be used on the same network.

The following illustration shows an example of how to configure the network when using both internal and external devices:

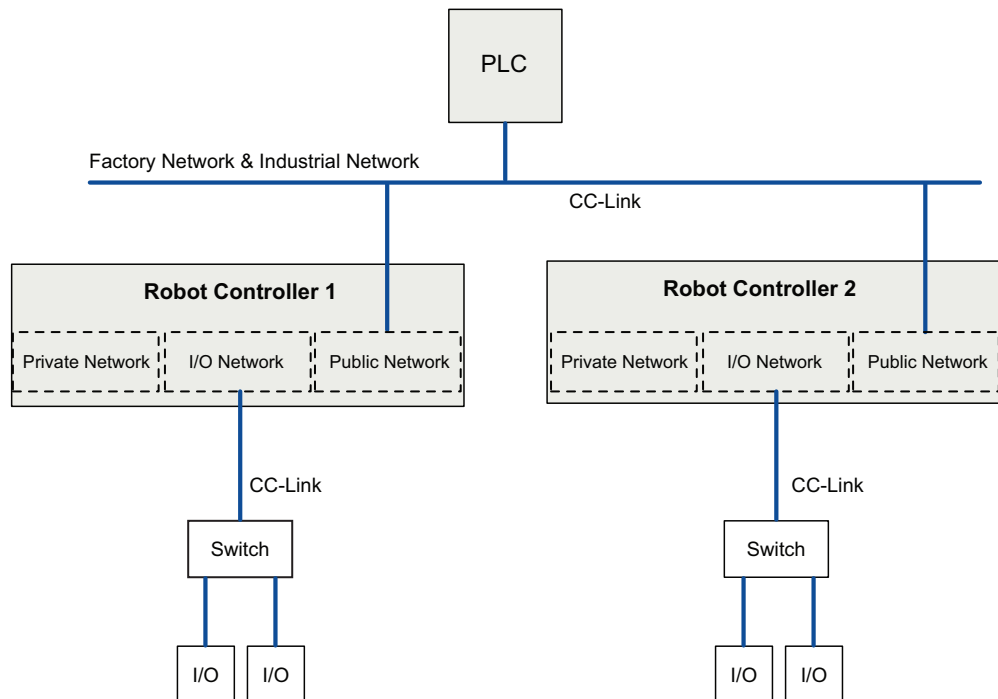

xx2300001538

2 Quick start instructions

Quick start

The CC-Link IE Field Basic system is predefined. Follow this procedure for a quick start of the CC-Link IE Field Basic functionality:

- Create a system with options 3066-1 *CC-Link IE Field Basic Master* and/or 3066-2 *CC-Link IE Field Basic Device*. See *Operating manual - Integrator's guide OmniCore*.
- Define the IP address on the robot controller physical port to be used. See *Operating manual - Integrator's guide OmniCore*.
- Open the firewall for the ports using the **Firewall Manager**. See *Operating manual - Integrator's guide OmniCore*.
- Connect the CC-Link IE Field Basic equipment to the physical port.
- Configure the system using I/O Engineering in RobotStudio. See [Configuring the CC-Link IE Field Basic system on page 21](#) and *Application manual - I/O Engineering*.

This page is intentionally left blank

3 Setting up your CC-Link IE Field Basic system

Log in with configuration grant

For configuration in I/O Engineering, the user grant **Modify configuration** is required. See *Operating manual - RobotStudio*, section *Managing user rights and write access on a controller*.

Start I/O Engineering

- 1 Start RobotStudio and connect to the robot system to configure.
 - 2 In the ribbon of the **Controller** tab, select **I/O Engineering**.
See *Application manual - I/O Engineering* for more information.
-

Configure IP settings

IP settings for the CC-Link IE Field Basic network used on the Public or I/O Network are defined in **Network Settings** in RobotStudio or on the FlexPendant. See *Operating manual - RobotStudio* and *Operating manual - Integrator's guide OmniCore*.

Configure firewall settings

The Firewall Management function is used to configure the network firewall on the controller. Configuration is done in RobotStudio under **Configuration\Communication\Firewall Manager** where pre-configured Network Services can be enabled or disabled. See *Operating manual - RobotStudio* and *Operating manual - Integrator's guide OmniCore*.

Configure the network properties

- 1 In the **Controller** tab in RobotStudio, select **I/O Engineering**. The **I/O Engineering** tab is displayed.
 - 2 In the **Configuration** browser, select **CC_Link_IE** (under I/O system).
-

Continues on next page



3 Setting up your CC-Link IE Field Basic system

Continued

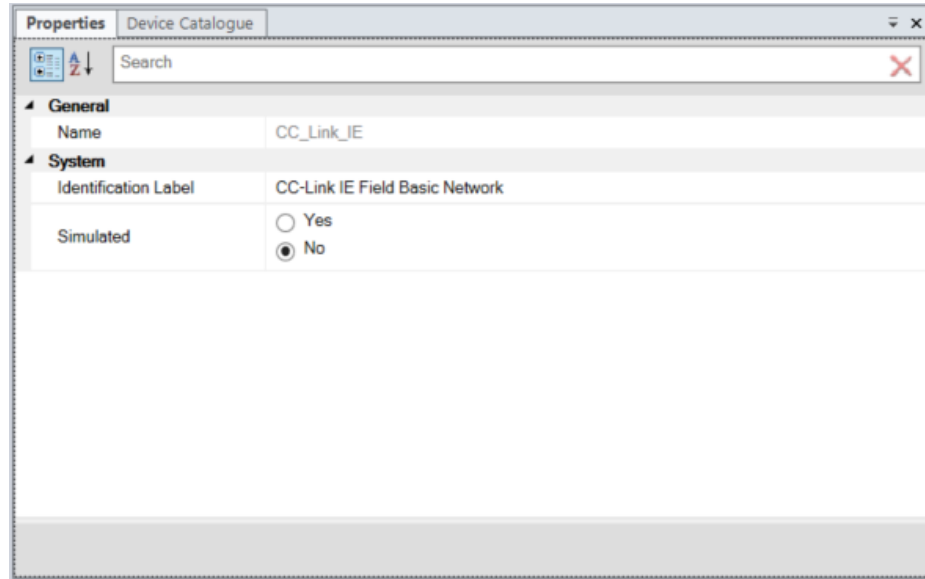
3 In the **Properties** browser, you can configure the following:



xx2200000238

Parameter	Description	Allowed values
Identification Label	<p>This parameter is an optional way to provide a label that will help the operator to identify the internal device.</p> <p> Note</p> <p>If this information is changed, it is updated both for the network and the master.</p>	A string with maximum 80 characters.
Simulated	<p>Select Yes or No, indicating if the industrial network and all its connected I/O devices should be treated as simulated.</p> <p> Note</p> <p>If this information is changed, it is updated for all devices connected to the network and the master.</p>	The default value is No.

Import CSP+ files

A CSP+ file contains data about a device. It is necessary to add CSP+ files for all devices that should be added. It is also possible to add CSP+ files for any devices that may be added later.

- 1 In the **I/O Engineering** tab, select **Import files > CSP+ Files**, or right-click on **CC_Link_IE** (under I/O system) and select **Manage CSP+ files**.

Continues on next page

- 2 The **CSP+ Files** window is displayed. Click **Import** and browse for an CSP+ file, or **Import, Folder** to import a complete folder with CSP+ files.



Note

The **Used CSP+ files** window shows all CSP+ files that are used in the current I/O project.

The **Imported CSP+ files...** window shows all CSP+ files that are imported into the I/O project but are not used in the configuration.



Note

When a new I/O project is opened, only the used CSP+ files will be shown in the **Imported CSP+ files...** window. Click **Update** to display all previously imported, but not used, CSP+ files.

This page is intentionally left blank

4 Configuring the CC-Link IE Field Basic system



4.1 Configuring the internal device properties

Configure the internal device properties

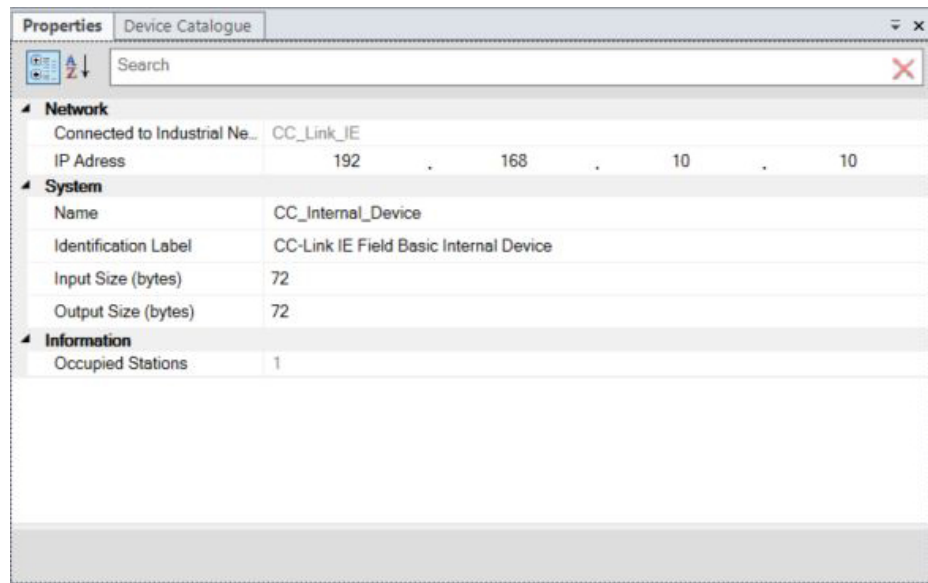
- 1 In the **Controller** tab in RobotStudio, select **I/O Engineering**. The **I/O Engineering** tab is displayed.
- 2 In the **Configuration** browser, select the internal device.
- 3 In the **Properties** browser, you can configure the following:



xx2200000215

Parameter	Description	Allowed values
IP Address	<p>Enter the IP address for the interface port on the controller to be used by the device.</p> <p>For example, if the internal device should communicate on the public network, enter the IP address for that interface.</p> <p> Note</p> <p>Only displayed if option 3066-1 <i>CC-Link IE Field Basic Master</i> is used.</p> <p> Note</p> <p>The options 3066-1 <i>CC-Link IE Field Basic Master</i> and 3066-2 <i>CC-Link IE Field Basic Device</i> cannot be configured on the same interface. If only the option 3066-2 <i>CC-Link IE Field Basic Device</i> is used, the internal device will automatically detect what interface to use.</p>	
Name	Enter the name to be used for the device.	A string with maximum 32 characters.

Continues on next page

4 Configuring the CC-Link IE Field Basic system

4.1 Configuring the internal device properties

Continued

Parameter	Description	Allowed values
Identification Label	This parameter is an optional way to provide a label that will help the operator to identify the device.	A string with maximum 80 characters.
Input Size	Enter the input size.	0 - 288
Output Size	Enter the output size.	0 - 288



Note

The field **Occupied Stations** is automatically updated when the **Input Size** or **Output Size** is changed. The maximum value per station is 72. The device can have up to 4 stations.



4.2 Configuring the master network properties

Configure the master network properties

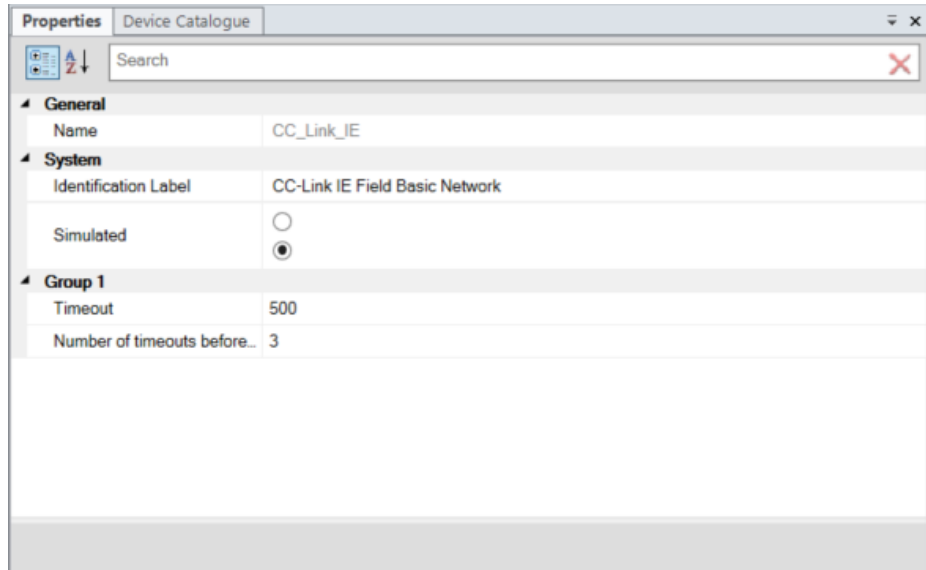
- 1 In the **Controller** tab in RobotStudio, select **I/O Engineering**. The **I/O Engineering** tab is displayed.
- 2 In the **Configuration** browser, select the master.
- 3 In the **Properties** browser, you can configure the following:



xx2300001380

Parameter	Description	Allowed values
Identification Label	<p>This parameter is an optional way to provide a label that will help the operator to identify the internal device.</p> <p> Note</p> <p>If this information is changed, it is updated both for the network and the master.</p>	A string with maximum 80 characters.
Simulated	<p>Select Yes or No, indicating if the industrial network and all its connected I/O devices should be treated as simulated.</p> <p> Note</p> <p>If this information is changed, it is updated both for the network and the master.</p>	The default value is No.
Timeout	<p>Define the timeout in milliseconds that the controller will wait for a response from a device.</p> <p> Note</p> <p>The defined value will be applied for all devices connected to this master.</p>	1 - 65535

Continues on next page

4 Configuring the CC-Link IE Field Basic system

4.2 Configuring the master network properties

Continued

Parameter	Description	Allowed values
Number of timeouts before disconnect	<p>Define the number of timeouts before the device is disconnected.</p> <p> Note</p> <p>The defined value will be applied for all devices connected to this master.</p>	1 - 65535

4.3 Adding external devices to the master

Add external devices

- 1 In the **Controller** tab in RobotStudio, select **I/O Engineering**. The **I/O Engineering** tab is displayed.
- 2 In the **Configuration** browser, select the master.
- 3 Select the **Device Catalogue** tab to show a list of available devices.



Note

The CSP+ files that have been imported to the project define what devices can be selected. See [Import CSP+ files on page 18](#).

- 4 Double-click on a device in the list to add it to the master.
- 5 Device information is retrieved from the CSP+ file, but some parameters can be changed in the **Properties** tab if needed. See [Configuring the external device properties on page 26](#).

4 Configuring the CC-Link IE Field Basic system

4.4 Configuring the external device properties

4.4 Configuring the external device properties

Configure the external device properties

- 1 In the **Controller** tab in RobotStudio, select **I/O Engineering**. The **I/O Engineering** tab is displayed.
- 2 In the **Configuration** browser, select the external device.
- 3 In the **Properties** browser, you can configure the following:

The screenshot shows the 'Properties' browser window in RobotStudio. The 'System' section is expanded, showing the following configuration:

Parameter	Value
Connected to Industrial Ne...	CC_Link_IE
IP Address	123 . 168 . 10 . 10
Name	CC_Device_A
Identification Label	CC-Link IE Field Basic Omnicore Device
Simulated	<input type="radio"/>
Trust Level	DefaultTrustLevel
State when System Startup	Activated
Input Size (bytes)	80
Output Size (bytes)	4
Group	1
Timeout	502
Number of timeouts before...	3
Occupied Stations	2
Vendor Code	
Device Model	
Device Version	
Vendor name	
Device type id	
Product id	
Description	
CSP+ file	

xx2300001414

Parameter	Description	Allowed values
IP Address	Enter the IP address for the device.	
Name	Enter the name to be used for the device.	A string with maximum 32 characters.
Identification Label	This parameter is an optional way to provide a label that will help the operator to identify the device.  Note If this information is changed, it is updated both for the internal device and the external device.	A string with maximum 80 characters.

Continues on next page

4 Configuring the CC-Link IE Field Basic system

4.4 Configuring the external device properties

Continued

Parameter	Description	Allowed values
Simulated	<p>Select Yes or No, indicating if the industrial network and all its connected I/O devices should be treated as simulated.</p> <p>Enter YES or NO indicating if the device is simulated on the industrial network.</p> <p> Note</p> <p>If this information is changed, it is updated both for the internal device and the external device.</p>	The default value is No.
Trust Level	Define the trust level to be used for this device. For more information about trust levels, see <i>Technical reference manual - System parameters</i> .	
State when System Startup	Define the logical state I/O device state at system startup: <ul style="list-style-type: none">• Activated Establish communication• Deactivated Do not establish communication• Last state Restore the previously stored logical state for the I/O device at system shutdown	
Input Size	Enter the input size.	0 - 288
Output Size	Enter the output size.	0 - 288



Note

The field **Occupied Stations** is automatically updated when the **Input Size** or **Output Size** is changed. The maximum value per station is 72. The device can have up to 4 stations.

4 Configuring the CC-Link IE Field Basic system

4.5 Working with signals

4.5 Working with signals

Overview

For internal devices, all signals are preloaded at installation. You can, however, edit the signals.

For external devices, no signals are preloaded, but new signals can be added.

For more information about working with signals, see *Application manual - I/O Engineering*.

4.6 Saving the configuration

Save configuration

When the configuration is finished, save the I/O project and write the configuration to the robot controller.

For more information about working with I/O projects, see *Application manual - I/O Engineering*.

This page is intentionally left blank

Index

C

CC-Link IE

data, 11

device, 12

standardization, 11

CC-Link IE versions

CC-Link IE Field Basic, 11

communication profiles, 11

compatibility, 12

CSP+ file, 11, 18

D

device, 12

F

firewall settings, 17

N

network security, 9

P

public network, 13

S

simulated, 18

T

topic I/O System

predefined internal device, 12



ABB AB

Robotics & Discrete Automation

S-721 68 VÄSTERÅS, Sweden

Telephone +46 10-732 50 00

ABB AS

Robotics & Discrete Automation

Nordlysvegen 7, N-4340 BRYNE, Norway

Box 265, N-4349 BRYNE, Norway

Telephone: +47 22 87 2000

ABB Engineering (Shanghai) Ltd.

Robotics & Discrete Automation

No. 4528 Kangxin Highway

PuDong New District

SHANGHAI 201319, China

Telephone: +86 21 6105 6666

ABB Inc.

Robotics & Discrete Automation

1250 Brown Road

Auburn Hills, MI 48326

USA

Telephone: +1 248 391 9000

abb.com/robotics